

Design Stephan Veit



Cut, 910/PLR-Rocking
rocking bergère \ rocking bergère

Nella sua versione outdoor, Cut affianca alla bergère con poggiatesta la nuova poltroncina, lo sgabello, la sedia e la bergère a dondolo che ne ricalcano il profilo disegnato ed essenziale. La collezione prende forma da una struttura in tondino d'acciaio verniciato a polveri epossidiche, che disegna la silhouette armoniosa e longilinea di gambe e seduta, e da un guscio intrecciato a mano in fettuccia di gassa. L'intreccio accoglie il morbido cuscino di seduta a contrasto che enfatizza, grazie alle differenze cromatiche, i dettagli artigianali della lavorazione.

In its outdoor version, Cut complements the bergère with footrest with a new armchair, stool, chair and rocking bergère that follow its designed and essential profile. The collection takes shape from an epoxy powdercoated steel rod frame, which designs the harmonious, long-line silhouette of the legs and seat, and a hand-woven in beige "Gassa" ribbon. The weave accommodates the soft contrasting seat cushion, which emphasizes the handcrafted details of the workmanship through color differences.

Informazioni tecniche \ Technical information

Descrizione tecnica \ Technical description

Bergère con struttura in tondino d'acciaio verniciato a polveri epossidiche finitura Aval o bianco goffrato, intrecciata a mano in fettuccia "Gassa" beige. Cuscino seduta e poggiatesta sono removibili e sfoderabili ed imbottiti in poliuretano espanso ignifugo con rivestimento sigillante e fodera esterna nei tessuti outdoor a collezione. Slitte in massello di Iroko. Finiture e rivestimenti di collezione.

Bergère with structure in epoxy powder coated steel rod in embossed Aval or white finish, hand-woven in beige "Gassa" ribbon. Seat cushion and headrest are removable and detachable and upholstered in fire-retardant polyurethane foam with sealing coating and external lining in the outdoor fabrics as per collection. Solid Iroko wood sleds. Materials and coverings as per collection.

Dimensioni \ Dimensions

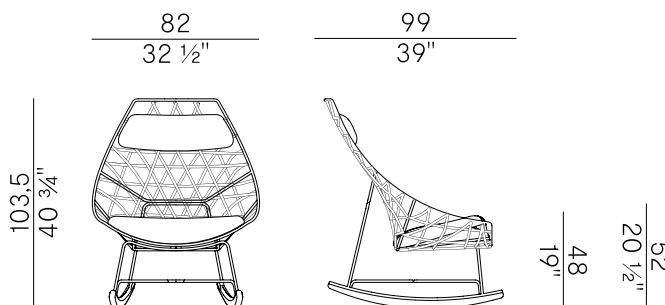

Consumi stoffe \ Fabric requirements

FABRIC REQUIREMENTS			
	x1	x2	
	H 140	ml 0,90	ml 1,70

FABRIC REQUIREMENTS			
	x1	x2	
	H 55 1/4"	yd 1,00	yd 1,85



PACKAGING

1 x box = m³ 0.85
gross weight – Kg 21

Finiture \ Finishes

Finiture struttura \
Frame finishes

Metallo verniciato \ Lacquered metal  

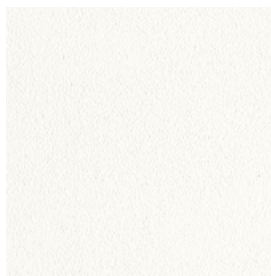

Aval gofrato \
Embossed Aval

Bianco gofrato \
Embossed white

Finiture intreccio \
Weaving finishes

Fettuccia \ Ribbon  



A7A
Gassa beige \
Gassa beige

Rivestimenti \
Coverings

Tessuto outdoor \ Outdoor fabric

Collezione outdoor Cut \
Cut outdoor collection

Collezione costituita da sedia e poltroncina dining, bergère, poggiatesta/pouf e sgabelli a due altezze. Struttura in tondino d'acciaio verniciato a polveri epossidiche finitura Aval o bianco goffrato, intrecciata a mano in fettuccia "Gassa" beige. Cuscini removibili e sfoderabili, imbottiti in poliuretano espanso ignifugo con rivestimento sigillante e fodera esterna nei tessuti outdoor a collezione. Rocking bergère con slitte in massello di iroko. Finiture e rivestimenti di collezione.

Collection composed of dining chair and armchair, bergères, footrest/pouf and two height stools. Structure in epoxy powder coated steel rod in embossed Aval or white finish, hand-woven in beige "Gassa" Ribbon. Cushions, removable and detachable, padded with fire retardant polyurethane foam with sealing coating and external lining in the outdoor fabrics as per collection. Rocking bergère with solid iroko wood sleds. Materials and coverings as per collection.

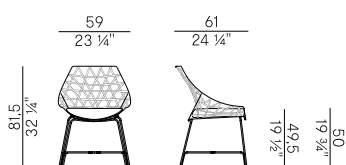

910/R
sedia dining \ dining chair

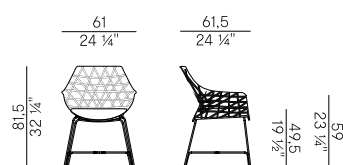

910/PR
poltroncina dining \ dining armchair

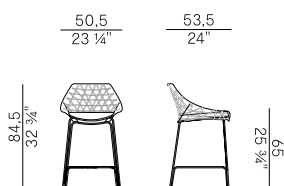

910/SR
sgabello basso \ counter stool

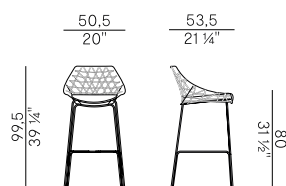

910/AR
sgabello alto \ barstool

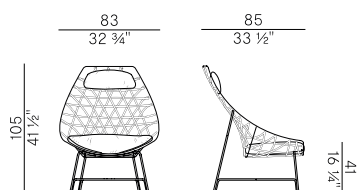

910/PLR
bergère \ bergère

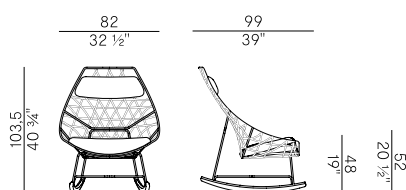

910/PLR-Rocking
rocking bergère \ rocking bergère

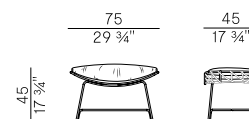

910/PPR
pouf \ pouf